

THANK YOU FOR BUYING A INDESIT PRODUCT

In order to receive a more complete assistance, please register your product on www.indesit.com/register



Before using the appliance carefully read the Safety Instruction.

Before using the machine, it is imperative that the transport bolts are removed. For more detailed instructions on how to remove them, see the Installation Guide.

CONTROL PANEL

1. ON/OFF button
2. TEMPERATURE button
3. OPTIONS buttons and indicator lights
4. START/PAUSE button and indicator light
5. DRYING button
6. SPIN button
7. WASH CYCLE SELECTOR KNOB
8. Detergent dispenser drawer

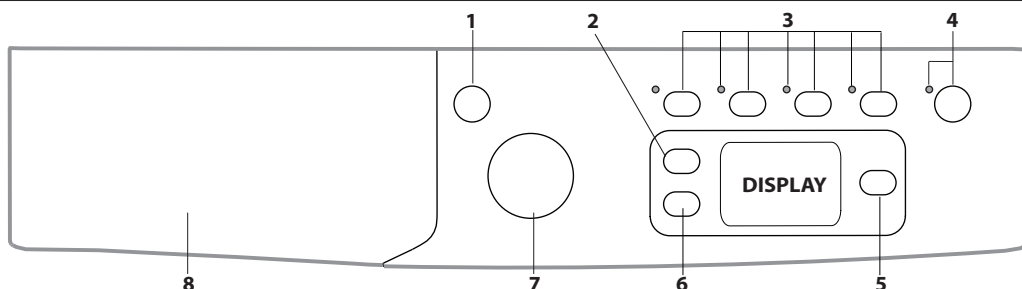

WASH CYCLE TABLE

Wash cycle		Temperature		Max. spin speed (rpm)	Max. load for washing (kg)	Duration (h : m)	Drying	Max. load for drying (kg)	Detergents and Additives		Recommended detergent		Residual dampness % (*)	Energy consumption kWh	Total water lt	Laundry temperature °C
		Setting	Range						Wash	Fabric softener	Powder	Liquid				
1	White	60°C	☼ - 90°C	1200	7.0	2:45	●	5.0	●	○	✓	✓	49	0.90	90	55
2	Mix Colours	40°C	☼ - 40°C	1200	7.0	**	●	5.0	●	○	-	✓	-	-	-	-
3	Synthetics (3)	40°C	☼ - 60°C	1200	4.0	2:55	●	4.0	●	○	✓	✓	35	0.80	55	43
4	Cotton (2)	40°C	☼ - 60°C	1200	7.0	3:55	●	5.0	●	○	✓	✓	49	1.40	105	45
5	Silk & Delicates	30°C	☼ - 30°C	600 (***)	2.0	**	-	-	●	○	-	✓	-	-	-	-
6	Wool	40°C	☼ - 40°C	800	2.0	**	-	2.0	●	○	-	✓	-	-	-	-
7	Jeans	40°C	☼ - 40°C	1200 (***)	4.0	**	●	4.0	●	○	-	✓	-	-	-	-
8	Sport Intensive	30°C	☼ - 30°C	600	4.0	**	-	-	●	○	-	✓	-	-	-	-
9	Eco 40-60 (1) (Wash)	40°C	40°C	1151	7.0	3:28	●	5.0	●	○	✓	✓	53	1.05	50	38
				1151	3.5	2:42	●		●	○	✓	✓	53	0.78	50	36
				1151	2.0	2:10	●		●	○	✓	✓	53	0.60	35	35
10	20°C	20°C	☼ - 20°C	1200	7.0	1:50	●	5.0	●	○	-	✓	49	0.16	90	22
11	Cotton Dry	-	-	0	-	**	●	5.0	-	-	-	-	-	-	-	-
12	Synthetics Dry	-	-	0	-	**	●	4.0	-	-	-	-	-	-	-	-
13	Express Wash&Dry	30°C	30°C	1200	0.5	**	●	0.5	●	○	-	✓	-	-	-	-
14	Rinse	-	-	1200	7.0	**	●	5.0	-	○	-	-	-	-	-	-
15	Spin	-	-	1200	7.0	**	●	5.0	-	-	-	-	-	-	-	-
16	Drain	-	-	0	7.0	**	-	-	-	-	-	-	-	-	-	-

● Required dosage ○ Optional dosage

9	Eco 40-60 (4) (Wash & Drying)	40°C	40°C	1151	5.0	9:50	●	5.0	●	○	✓	✓	0	4.50	75	34
				1151	2.5	5:40	●	2.5	●	○	✓	✓	0	2.50	52	35

The cycle duration indicated on the display or instruction manual is an estimate based on standard conditions. The actual duration may vary in relation to several factors, such as the temperature and pressure of the incoming water, ambient temperature, amount of detergent, load quantity and type, load balancing and any additional options selected. The values given for programmes other than the Eco 40-60 programme are indicative only.

1) Eco 40-60 (Wash) - Test wash cycle in compliance with EU Ecodesign regulation 2019/2014. The most efficient programme in terms of energy and water consumption for washing normally soiled cotton laundry.

Note: spin speed values shown on the display can slightly differs from the values stated in the table.

4) Eco 40-60 (Drying) - Test drying cycle in compliance with EU Ecodesign regulation 2019/2014. To access "wash and dry" cycle select "Eco 40-60" wash programme and set "Drying" option level to "A3". The most efficient programme in terms of energy and water consumption for washing and drying normally soiled cotton laundry. At the end of cycle the garments can be immediately stored to the cupboard..

For all testing institutes:

- 2) Long cotton cycle: set programme 4 at temperature 40°C.
- 3) Long synthetics cycle: set cycle 3 at a temperature of 40°C.

* After programme end and spinning with maximum selectable spin speed, in default programme setting.

** The duration of the wash cycles can be checked on the display.

*** The display will show the suggested spin speed as default value.

PRODUCT DESCRIPTION

1. Top
2. Detergent dispenser drawer
3. Control panel
4. Handle
5. Porthole door
6. Drain pump (behind the plinth)
7. Plinth (removable)
8. Adjustable feet (2)

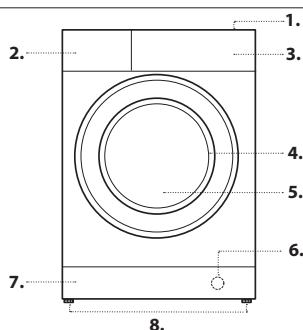

DETERGENT DISPENSER DRAWER

Compartment 1: Do not pour detergent into the compartment 1. Detergent should only be poured into the compartment 2.

Compartment 2: Washing detergent (powder or liquid)
Liquid detergent should only be poured in immediately prior to the start of the wash cycle.

Compartment 3: Additives (fabric softener, etc.)
The fabric softener should not overflow the grid.

! Use powder detergent for white cotton garments, for pre-washing, and for washing at temperatures over 60°C.

! Follow the instructions given on the detergent packaging.

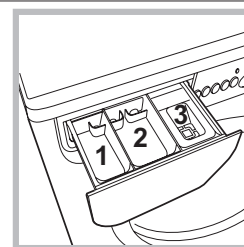

WASH CYCLES

Follow the instructions on the symbols of the garment's wash care label. The value indicated in the symbol is the maximum recommended temperature for washing the garment.

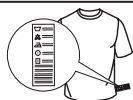

White

extremely soiled whites.

Mix Colours

A 40°C cycle that helps to preserve colours, suitable for cotton or synthetic coloured garments. It allows for reducing electricity consumption for heating the water while guaranteeing good washing results. Suitable for lightly soiled garments.

Synthetics

Specific for synthetic items. If the dirt is difficult to remove, the temperature can be increased up to 60° and powder detergent can be used too.

Cotton

Suitable for washing towels, underwear, table cloths, etc. made of resistant linen and cotton that are moderately to heavily soiled.

Silk & Delicates

To wash all silk and delicate garments. We recommend the use of special detergent which has been designed to wash delicate clothes.

Wool

all wool garments can be washed using programme 6, even those carrying the "hand-wash only"  label. For best results, use special detergents and do not exceed 2 kg of laundry.

Jeans

turn garments inside-out before washing and use a liquid detergent.

Sport Intensive

is for washing heavily soiled sports clothing fabrics (tracksuits, shorts, etc.); for best results, we recommend not exceeding the maximum load indicated in the "Wash Cycle Table".

Eco 40-60

For washing normally soiled cotton garments declared to be washable at 40 °C or 60 °C, together in the same cycle. This is the standard cotton programme and the most efficient in terms of water and energy consumption.

20°C

For washing lightly soiled cotton garments, at a temperature of 20 °C.

Cotton Dry

designed for drying cotton fabrics.

Synthetics Dry

designed for drying Synthetics fabrics.

Express Wash&Dry

was designed to wash and dry lightly soiled garments quickly. This cycle may be used to wash and dry a laundry load of up to 0.5 kg in just 30 minutes. To achieve optimum results, use liquid detergent and pre-treat cuffs, collars and stains.

Rinse

designed for rinsing and spinning.

Spin

designed to spin and drain the water.

Drain



designed for draining the water.

DISPLAY

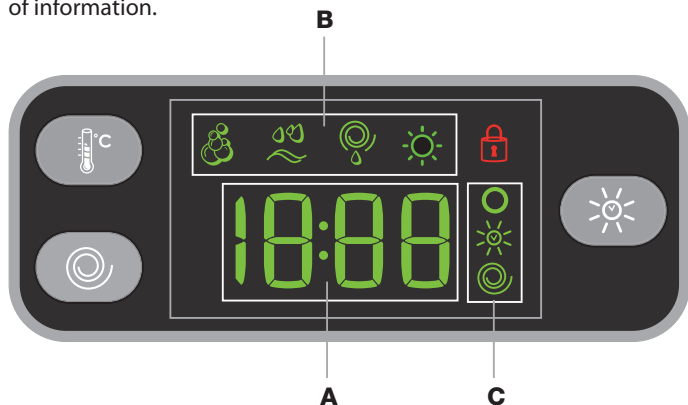
The display is useful when programming the machine and provides a lot of information.



The duration of the available programmes and the remaining time of a running cycle appear in section A; if the DELAY START option has been set, the countdown to the start of the selected programme will appear. Furthermore, pressing the corresponding button allows you to view the maximum temperature, spin speed and drying level or time values attained by the machine during the selected cycle. The "washing phases" relative to the selected cycle and the "washing phase" of the running cycle appear in section B:

-  Wash
-  Rinse
-  Spin / Drain
-  Drying



The icons corresponding to "temperature" , "Drying"  and "spin"  appear in section C from top to bottom:

If the  symbol lights up, the display will visualise the set "temperature" value.

The  symbol lights up while the drying settings are being adjusted. If the  symbol lights up, the display will visualise the set "spin" value.

DOOR LOCKED INDICATOR

When lit, the symbol indicates that the door is locked. To prevent any damage, wait until the symbol turns off before opening the door.





To open the door while a cycle is in progress, press the START/PAUSE button ; if the  symbol is off, the door can be opened.

FIRST-TIME USE





Once the appliance has been installed, and before it is used for the first time, run a wash cycle with detergent and no laundry, by setting the "1" cycle.

DAILY USE



Prepare the laundry by following the suggestions appearing under the "TIPS AND SUGGESTIONS" section.

- Press the ON/OFF button ; the START/PAUSE  indicator light will flash slowly green.
- Open the door. Load the laundry while making sure not to exceed the maximum load quantity indicated in the Wash Cycle Table.
- Pull out the detergent dispenser drawer and pour the detergent into the relevant compartments as described in "DETERGENT DISPENSER DRAWER" section.
- Close the door.
- Set the WASH CYCLE knob to the desired programme; a temperature and spin speed is set for each wash cycle; these may be adjusted. The duration of the cycle will appear on the display.
- Modify the temperature and/or spin speed: The machine automatically displays the maximum temperature and spin speed values set for the selected cycle, or the most recently-used settings if they are compatible with the selected cycle. The temperature can be decreased by pressing the  button, until the cold wash "OFF" setting is reached. The spin speed may be progressively reduced by pressing the  button, until it is completely excluded (the "OFF" setting). If these buttons are pressed again, the maximum values are restored.
- Set the drying cycle if necessary.
- Select the desired options.





STARTING CYCLE

Press the START/PAUSE  button. The machine will lock the door ( symbol on) and the drum will start to rotate; the door will be unlocked ( symbol OFF) and then locked again ( symbol on) as preparation phase of each washing cycle. The "Clicking" noise is part of the door locking mechanism. Water will enter the drum and start the washing phase once the door is locked.



PAUSING A CYCLE

To pause the wash cycle, press the START/PAUSE  button again; the indicator light will flash amber. If the  symbol is not lit, the door may be opened. To start the wash cycle from the point at which it was interrupted, press the START/PAUSE  button again.

OPENING THE DOOR, IF NECESSARY



Once a cycle starts, the  symbol turns on to signal that the door cannot be opened. While a wash cycle is running, the door remains locked. To open the door while a cycle is under way, for example, to add or remove garments, press the START/PAUSE  button to pause the cycle; the indicator light will flash amber. If the  symbol is not lit, the door may be opened. Press the START/PAUSE  button again to continue the cycle.

CHANGING A RUNNING WASH CYCLE

To change a wash cycle while it is in progress, pause the washer-dryer using the START/PAUSE  button (the relative indicator light will flash amber), then select the desired cycle and press the START/PAUSE  button again.

! To cancel a cycle that has already begun, press and hold the ON/OFF  button. The cycle will be stopped and the machine will switch off.

END OF THE CYCLE

This will be indicated by the text "End" on the display; when the  symbol switches off, the door may be opened. Open the door and switch off the machine. If you do not press ON/OFF  button, the washer-dryer will switch off automatically after about a 10 minutes. Close the water tap and unload the washer-dryer. Leave the door ajar to allow the drum to dry.

OPTIONS

- If the selected option is not compatible with the programmed wash cycle, the indicator light will flash and the option will not be activated.
- If the selected option is not compatible with another option which has been selected previously, the indicator light corresponding to the first option selected will flash and only the second option will be activated; the indicator light corresponding to the enabled option will remain lit.

Time Saver

Selecting this option enables you to suitably adjust drum rotation, temperature and water to a reduced load of lightly soiled cotton and synthetic fabrics. **Time Saver** enables you to wash in less time thereby saving water and electricity. We suggest using a liquid detergent suitably measured out to the load quantity.

Intensive Wash

Because a greater quantity of water is used in the initial phase of the cycle, and because of the increased cycle duration, this function offers a high-performance wash.

Easy Iron

By selecting this function, the wash and spin cycles will be modified in order to reduce the formation of creases. For the 5 wash cycle, the machine will end the cycle while the laundry is soaking and the EASY IRON and START/PAUSE >|| indicator lights will flash. To drain the water so that the laundry may be removed, press the START/PAUSE >|| button or the EASY IRON button.

Delay Timer

To set a delayed start for the selected programme, press the corresponding button repeatedly until the required delay period has been reached. To remove the delayed start option press the button until the text "OFF" appears on the display.

Temperature

Each wash cycle has a pre-defined temperature. To modify the temperature, press the  button. The value will appear on the display.

Spin

Each wash cycle has a pre-defined spin speed. To modify the spin speed, press the  button. The value will appear on the display.

Drying cycle

The first time the button is pressed, the machine will automatically select the maximum drying cycle which is compatible with the selected wash cycle. Subsequent presses will decrease the drying level and then the drying time, until the cycle is excluded completely ("OFF").

Drying may be set as follows.

A - Based on the desired laundry dryness level:

Iron dry: suitable for clothes which will need ironing afterwards. The remaining dampness softens creases, making them easier to remove; "A1" appears on the display.

Hanger dry: ideal for clothes which do not need to be dried fully; "A2" appears on the display.

Cupboard dry: suitable for laundry which can be put back in a cupboard without being ironed; "A3" appears on the display.

Extra dry: suitable for garments which need to be dried completely, such as sponges and bathrobes "A4"; appears on the display.

B - Based on a set time period: between **30** and **180** minutes.

If your laundry load to be washed and dried is much greater than the maximum stated load (see WASH CYCLE TABLE), perform the wash cycle, and when the cycle is complete, divide the garments into groups and put some of them back in the drum. At this point, follow the instructions provided for a "Drying only" cycle. Repeat this procedure for the remainder of the load.

N.B: a cooling-down period is always added to the end of each drying cycle.

Drying only

Use the cycle selector knob to select a drying cycle (11-12) in accordance with the type of fabric. The desired drying level or time may also be set using the DRYING button .

TIPS AND SUGGESTIONS

Divide the laundry according to:

Type of fabric (cotton, mixed fibres, synthetics, wool, garments to be hand-washed). Colour (separate coloured garments from whites, wash new coloured garments separately). Delicates (small garments – such as nylon stockings – and items with hooks – such as bras: insert them in a fabric bag).

Empty the pockets:

Objects such as coins or lighters can damage the washer-dryer and the drum. Check all buttons.

Follow the dosage recommendation / additives

It optimizes the cleaning result, it avoids irritating residues of surplus detergent in your laundry and it saves money by avoiding waste of surplus detergent.

Use low temperature and longer duration

The most efficient programmes in terms of energy consumption are generally those that perform at lower temperatures and longer duration.

Observe the load sizes

Load your washing machine up to the capacity indicated in the "Wash Cycle Table" table to save water and energy.

Noise and remaining moisture content

They are influenced by the spinning speed: the higher the spinning speed in the spinning phase, the higher the noise and the lower the remaining moisture content.

CARE AND MAINTENANCE

Before performing cleaning and maintenance, switch the washer-dryer off and disconnect it from the mains power. Do not use flammable liquids to clean the washer-dryer. Clean and maintain your washer-dryer periodically (at least 4 times per year).

Disconnect the water and power supplies

Close the water tap after every wash. This will limit wear on the hydraulic system inside the washer-dryer and help to prevent leaks.

Unplug the washer-dryer when cleaning it and during all maintenance work.

Clean the washer-dryer

The outer parts and rubber components of the appliance can be cleaned using a soft cloth soaked in lukewarm soapy water. Do not use solvents or abrasives.

Clean the detergent dispenser drawer

Wash it under running water; this operation should be repeated frequently.

Care for the door and drum

Always leave the porthole door ajar in order to prevent unpleasant odours from forming.

Clean the pump

The washer-dryer is fitted with a auto-cleaning pump that does not require any maintenance. Small items (such as coins or buttons) may sometimes fall into the protective pre-chamber situated at the base of the pump.

! Make sure the wash cycle has ended and unplug the appliance.

To access the pre-chamber:

1. remove the cover panel on the front of the machine by first pressing it in the centre then pushing downwards on both sides to extract it;
2. loosen the drainage pump cover by turning it anti-clockwise: it is normal for some water to leak out;
3. clean the inside thoroughly;
4. screw the cover back on;
5. put the panel back in place, making sure the hooks slot in place before pushing the panel onto the appliance.

Check the water inlet hose

Check the water inlet hose at least once a year. If it is cracked or broken, it must be replaced: during wash cycles, the high pressure of the water could suddenly split the hose open.

! Never use hoses that have already been used.

LOAD BALANCING SYSTEM

Before every spin cycle, to avoid excessive vibrations before every spin and to distribute the load in a uniform manner, the drum rotates continuously at a speed which is slightly greater than the washing rotation speed. If, after several attempts, the load is not balanced correctly, the machine spins at a reduced spin speed. If the load is excessively unbalanced, the washer-dryer performs the distribution process instead of spinning. To encourage improved load distribution and balance, we recommend small and large garments are mixed in the load.

ACCESSORIES

Contact our Technical Assistance Service to check whether the following accessories are available for this washer-dryer model.

Stacking kit

With this accessory you can secure the tumble dryer to the upper part of your washer-dryer to save space and facilitate loading and unloading of the tumble dryer.







TRANSPORT AND HANDLING

Do not lift the washer-dryer by gripping it from the upper section.

Unplug the appliance and close the water tap. Check that the door and detergent dispenser drawer are tightly closed. Detach the filling hose from the water tap then detach the drain hose. Empty all the water remaining in the hoses and secure the latter so that they do not get damaged during transport. Apply the transport bolts back on. Repeat, in reverse order, the transport bolt removal procedure described in the "Health & Safety and Installation Guides".

TROUBLESHOOTING

The washer-dryer may occasionally fail to work. Before contacting the Technical Assistance Service, make sure that the problem cannot be easily solved using the following list.

Anomalies	Possible causes / Solution
The washing machine does not start.	The appliance is not plugged into the socket, or not sufficiently to make contact. There is no power in the house.
The wash cycle does not start.	The washing machine door is not closed properly. The ON/OFF  button has not been pressed. The START/PAUSE  button has not been pressed. The water tap has not been opened. A delay has been set for the start time.
The washing machine does not fill with water ("H2O" flashes on the display).	The water inlet hose is not connected to the tap. The hose is bent. The water tap has not been opened. There is no water supply in the house. The pressure is too low. The START/PAUSE  button has not been pressed.
The washing machine continuously loads and unloads water.	The drain hose is not fitted between 65 and 100 cm from the floor. The free end of the hose is immersed in water. The wall drainage system does not have a breather pipe. If the problem persists even after these checks, turn off the water tap, switch the appliance off and contact the Technical Assistance Service. If the home is on one of the upper floors of a building, there may be problems relating to back-siphonage, causing the washing machine to fill with water and drain continuously. Special anti-siphon valves are available in shops and help to prevent this inconvenience.
The washing machine does not drain or spin.	The cycle does not include drainage: with certain cycles it must be started manually. The drain hose is bent. The "Easy iron" option has been activated: To complete the wash cycle, press the START/PAUSE  button. The drainage duct is clogged.
The washing machine vibrates a lot during the spin cycle.	The drum was not unlocked correctly during installation. The washing machine is not level. The washing machine is tucked between furniture cabinets and the wall.
The washing machine leaks.	The water inlet hose is not screwed on properly. The detergent dispenser drawer is obstructed. The drain hose is not properly attached.
The "Options" indicator lights and the START/PAUSE  indicator light flash and an error code appears on the display (e.g.: F-01, F-...).	Switch off the machine and unplug it, wait for approximately 1 minute and then switch it back on again. If the problem persists, contact the Technical Assistance Service .
There is too much foam.	The detergent is not suitable for machine washing (it should be marked with "for washing machine use" or "hand wash and machine wash" or similar). Too much detergent was used.
The wash cycle does not start.	The appliance is not plugged into the socket, or not sufficiently to make contact. There is no power in the house. The washer-dryer door is not closed properly. The ON/OFF  button has not been pressed. The START/PAUSE  button has not been pressed. The water tap has not been opened. A delay has been set for the start time. The 'DRYING' selector knob is in the OFF position.



You can download the Safety Instructions, Product Fiche and Energy data by:

- Visiting our website - <http://docs.indesit.eu>
- Using QR Code
- Alternatively, **contact our After-sales Service** (See phone number in the warranty booklet). When contacting our After-sales Service, please state the codes provided on your product's identification plate.
- For User's Repair & Maintenance Information visit www.indesit.com

The model information can be retrieved using the QR-Code reported in the energy label. The label also includes the model identifier that can be used to consult the portal of the registry at <https://eprel.ec.europa.eu>

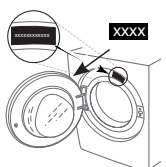

400011643563