

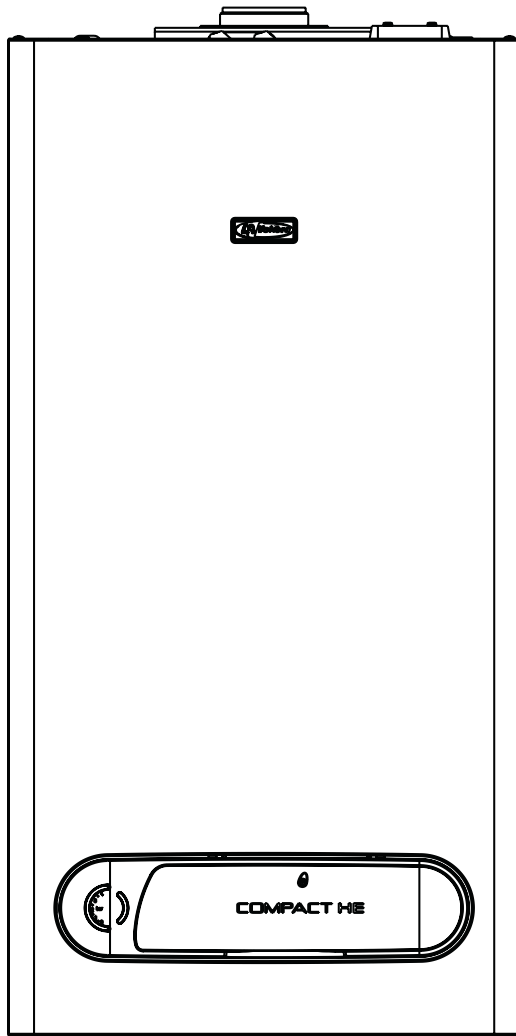

# COMPACT HE



## Users Instructions



THESE INSTRUCTIONS  
TO BE RETAINED  
BY USER



*The code of practice for the installation,  
commissioning & servicing of central heating systems*

## Contents

Introduction		Page
Dear customer		2
Do's and don't's		2

Things you should know		Page
1.1	Gas appliance	3
1.2	Electrical supply	3
1.3	Explanation of controls	3
1.3.1	Mode selector switch...	3
1.3.2	Hot water...	3
1.3.3	Heating and hot water...	3
1.3.4	Time clock	3
1.4	Explanation of features	3
1.4.1	Frost protection mode	3
1.4.2	Automatic temperature control	3
1.4.3	Anti seize function	4
1.4.4	Appliance status indicators	4
1.5	Guarantee registration card	4
1.5.1	Benchmark log book	4

How to...		Page
2.1	Use the appliance for the 1 <sup>st</sup> time	4
2.2	Use the mode selector switch	4
2.2.1	Obtain hot water	4
2.2.2	Obtain central heating	4
2.3	Re-pressuring the system	4
2.4	Shut down the system for short periods	4
2.5	Shut down the system for long periods	4
2.6	Care for the appliance	4

What if...		Page
3.1	I suspect a gas leak	5
3.2	I frequently have to top-up the system	5
3.3	The fault light is on	5
3.4	The appliance is due its annual service	5
3.5	I need to call an engineer	5
3.6	I want to extend the warranty	5

## INTRODUCTION

### Dear Customer

Your Vokera Compact HE boiler has been designed to meet and exceed the very latest standards in gas central heating technology and if cared for, will give years of reliable use and efficiency.

Your Vokera Compact HE a combination boiler supplying central heating and instantaneous domestic hot water. Features included are an integral time clock, LED indicators showing the status of the appliance and system pressure gauge, frost protection and anti-pump seize function.

Please therefore take some time to read these instructions carefully.

### Do's and don't's

- **Do** ensure that the system pressure is periodically checked
- **Do** ensure that you know how to isolate the appliance in an emergency
- **Do** ensure that you are familiar with the appliance controls
- **Do** ensure that your installer has completed the appliance log book
- **Do not** attempt to remove the appliance casing or gain internal access
- **Do not** hang clothes etc. over the appliance
- **Do not** operate on sealed components
- **Do not** forget to have the appliance serviced annually.

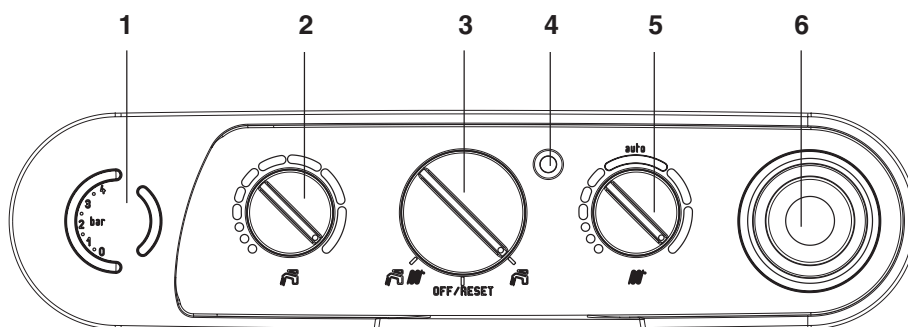

- 1= Pressure gauge
- 2= DHW temperature selector 40 - 65 °C
- 3= Mode selector switch
- 4= Appliance LED status indicator
- 5= Heating temperature selector 40 - 80 °C
- 6= Timeclock

Fig. 1

## THINGS YOU SHOULD KNOW

### 1.1 GAS APPLIANCE

#### Gas safety (Installation and Use) regulations

In the interests of your safety and that of others, it is a legal requirement that all gas appliances are installed and correctly maintained by a competent person and in accordance with the latest regulations.

### 1.2 ELECTRICAL SUPPLY

Please ensure that this appliance has been properly connected to the electrical supply by means of a double pole isolator or un-switched socket and that the correct size of fuse - 3 amp - has been fitted.

**Warning: this appliance must be earthed!**

### 1.3 EXPLANATION OF CONTROLS

The Vokera Compact HE has been designed for simplicity of use, as a result there are only two controls - the mode selector switch & the time clock - that can be accessed by the user.

#### 1.3.1 MODE SELECTOR SWITCH AT:

**OFF:** when the mode selector switch is in the 'OFF' position, the appliance will not function for hot water or heating. However the appliance will still operate in frost protection mode, and if unused for a period of 24 hours, will momentarily activate the pump and valve actuator to prevent seizure due to non-use.

#### NOTE

The appliance must have an electrical supply at all times for the frost protection and anti-seize modes to operate.

**1.3.2 HOT WATER ONLY** “”: when the mode selector switch is in the 'HOT WATER ONLY' position, the appliance will operate as above. However when a hot water outlet is opened the appliance will operate to provide hot water until the demand for hot water has been satisfied.

#### NOTE

The appliance delivers a fixed maximum flow rate of hot water, therefore if a hot water outlet is

turned on full, it is most likely that you will be unable to obtain hot water from another outlet at the same time.

**1.3.3 HEATING AND HOT WATER** “”: when the mode selector switch is in the 'HEATING AND HOT WATER' position the appliance will operate as above. However should the time clock be switched on automatically or manually, the appliance will operate to provide heat to the central heating circuit until the demand has been satisfied.

#### NOTE

If a room thermostat is fitted it must be calling for heat before the appliance will operate.

#### 1.3.4 TIME CLOCK

The Vokera Compact HE is supplied with a built-in, 24-hour, time clock that can be set to operate the appliance for central heating. However it may be that your installer has fitted an external time clock (usually because of the location of the appliance i.e. loft, basement, outhouse, etc.) if so, please disregard the following instructions and refer to those supplied with the external time clock.

### 1.4 EXPLANATION OF FEATURES

Although the Vokera Compact HE has been designed for simplicity of use, it utilises the latest in boiler technology, enabling a host of functions to be carried out simultaneously.

#### 1.4.1 FROST PROTECTION MODE

This function is only active when there are no requests for heating or HW. When the temperature inside the appliance drops below 5 °C, the boiler will operate on minimum output until the temperature - within the appliance - reaches 35 °C.

#### 1.4.2 AUTOMATIC TEMPERATURE CONTROL

The automatic temperature control function (SARA), permits the boiler (when the heating temperature selector is set within the AUTO sector) to automatically adjust (raise) the heating flow outlet temperature during inclement weather.

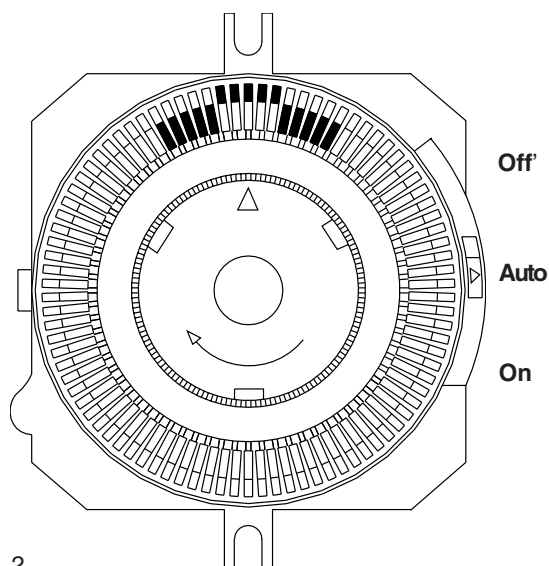

Fig. 2

#### Setting the time

The time of day can be set by grasping the outer edge of the black dial and turning it in a clockwise direction until the correct time is in line with the white pointer.

#### Setting the 'switching times'

The 'ON' periods are set by sliding the black tappets, adjacent to the time periods required, to the outer edge of the dial.

The tappets that remain at the centre of the dial will be the 'OFF' periods.

The smallest switching time (ON or OFF) is 15 minutes.

To select 'Auto' mode move the selector switch in central position.

To select 'On' mode move the selector switch in the bottom position.

To select 'Off' mode move the selector switch in the upper position.

### 1.4.3 ANTI-SEIZE FUNCTION

Should the appliance remain inactive for a period of 24 hours, the pump will be activated for a few seconds to prevent seizure.

### 1.4.4 APPLIANCE STATUS INDICATORS

The Vokera Compact HE has status indicators that show if the appliance is working normally, if it needs 'topping up' or re-pressurising, or if it has a fault (see below).

### 1.5 GUARANTEE REGISTRATION CARD

Please take the time to fill out your guarantee registration card. The completed warranty card should be posted within 30 days of installation.

### 1.5.1 BENCHMARK LOG BOOK

The **Benchmark** Log Book is supplied with your boiler. This important document must be completed during the installation/commissioning of your boiler. All CORGI Registered Installers carry a CORGI ID card, and have a registration number. Both should be recorded in your **Benchmark** Log Book. You can check your installer by calling CORGI direct on 01256 372300.

Failure to install and commission the appliance in accordance with the manufacturers instructions may invalidate the warranty. This does not affect your statutory rights .

## HOW TO...

### 2.1 USE THE APPLIANCE FOR THE FIRST TIME

Before switching the appliance on please familiarise yourself on how to isolate the appliance from the electricity, gas, and water supplies. If in doubt contact your installer.

### 2.2 USE THE MODE SELECTOR SWITCH

Turn the mode selector switch to the OFF position, switch on the electrical supply to the appliance. The green LED should be flashing, you may now select either HOT WATER ONLY or HEATING AND HOT WATER.

#### 2.2.1 OBTAIN HOT WATER

By turning on a hot water outlet (tap) the boiler will fire to deliver hot water.

The appliance will have been commissioned by your installer to deliver hot water at both a reasonable temperature and flow rate, should you wish to alter the temperature of the hot water, simply change the setting of the DHW temperature selector and/or change the flow of water as it comes out of the tap. Please consult your installer for further advice if required.

#### 2.2.2 OBTAIN CENTRAL HEATING

When the time clock is in an 'on' position, and the room thermostat – if fitted – is calling for heat, the boiler will fire to provide central heating.

### 2.3 RE-PRESSURING THE SYSTEM

The system will need re-pressurising if the red LED is illuminated and the pressure gauge is reading below 0.4bar. Locate the filling valve and if necessary connect the loop (fig. 3) slowly open the valve until you hear the water entering the appliance. The red LED will go out first. Go on with re-pressuring until the pressure shown on the manometer is between 1 & 1.5 bar (fig. 4). The appliance must not be operated until the system has been re-pressurised. If in doubt contact your installer.

### 2.4 SHUT DOWN THE SYSTEM FOR SHORT PERIODS

The system can be shut down for short periods by simply turning the mode selector to the OFF position. It is also advisable to turn off the main water supply to the house.

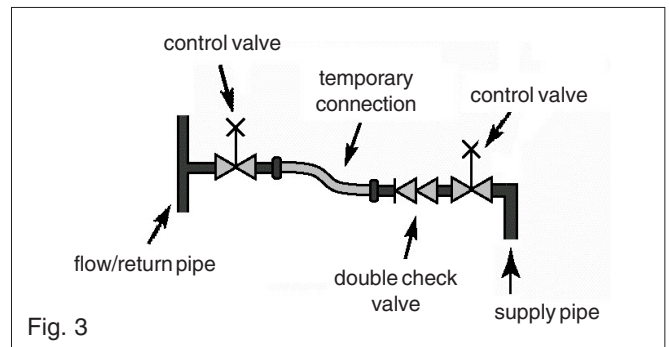

Fig. 3

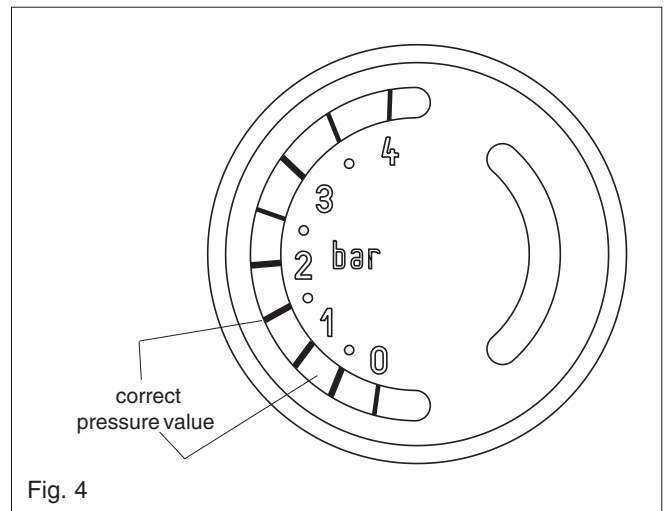

Fig. 4

### 2.5 SHUT DOWN THE SYSTEM FOR LONG PERIODS

If the house is to be left unoccupied for any length of time – especially during the winter - the system should be thoroughly drained of all water. The gas should be turned off at the meter and the main water supply should be turned off at the stopcock. If necessary contact your installer for further advice.

### 2.6 CARE FOR THE APPLIANCE

To clean the outer casing use only a clean damp cloth. Do not use any scourers or abrasive cleaners.

## APPLIANCE LED STATUS INDICATOR

COLOUR	FREQUENCY	FAULTS/STATUS	ACTION REQ'D
<b>Green</b>	Flashing every 6-seconds	At stand-by with no faults	None
	Flashing 8-times every second	SARA function	None
	On every 0.5 second	Temporary fault	Wait
<b>Yellow</b>	On every 0.5 second	Service function	Contact service centre
	On permanently	DHW fault	Contact service centre
<b>Red</b>	On every 0.5 second	Safety shutdown and/or internal fault	Check pressure gauge Check gas supply Leave 2-minutes and reset appliance, if fault continues, contact service centre
	On permanently	Appliance overheat	Contact service centre

## WHAT IF...

### 3.1 I SUSPECT A GAS LEAK

If you suspect a gas leak, turn off the gas supply at the gas meter, and contact your installer or local gas supplier. If you require further advice please contact your nearest Vokera office.

### 3.2 I FREQUENTLY 'TOP-UP' OR 'RE-PRESSURISE' THE SYSTEM

If the system regularly requires topping-up or re-pressurising, it may be indicative of a leak. Please contact your installer and ask him to inspect the system.

### 3.3 THE FAULT LIGHT IS ON

If the red LED is illuminated it indicates that the appliance has 'locked-out' or has an internal fault. To reset the appliance, make sure the gas supply is on to the appliance. Turn the mode selector switch to the OFF position for a few seconds and then turn it back to its previous position. If the red LED stays on or is illuminated after a few seconds call an engineer.

### 3.4 THE APPLIANCE IS DUE ITS ANNUAL SERVICE

Please contact Vokera Customer Services (**0870 333 0220 U.K. or 05655057 R.O.I.**) if you would prefer a Vokera service engineer or agent to

service your appliance. Alternatively your local CORGI registered engineer may be able to service the appliance for you. If you are a tenant your landlord will arrange for servicing.

### 3.5 I NEED TO CALL AN ENGINEER

If you think your boiler may have developed a fault, please contact your installer or Vokera customer services (**0870 333 0220 U.K. or 05655057 R.O.I.**). Have all your details to hand including full address and postcode, relevant contact numbers and your appliance logbook.

### 3.6 I WANT TO EXTEND THE WARRANTY

Vokera offer extended warranties on all current Vokera appliances, simply contact customer services (**0870 333 0220 U.K. or 05655057 R.O.I.**) for further information.

## MINIMUM CLEARANCES

Please observe the following minimum clearances required for the safe operation and maintenance of this appliance

Above the appliance	150mm	6 inches
Below the appliance	150mm	6 inches
Left hand side of appliance	50mm	2 inches
Right hand side of appliance	12mm	1/2 inch
In front of appliance	600mm	24 inches







Vokèra Ltd.

4<sup>th</sup> Floor, Catherine House, Boundary Way, Hemel Hempstead, Herts, HP2 7RP

Email: [enquiries@vokera.co.uk](mailto:enquiries@vokera.co.uk) Web: [www.vokera.co.uk](http://www.vokera.co.uk)

Sales, Technical Advice, General Enquiries - Tel: 0870 333 0520 Fax: 01442 281403

**After Sales Service - Tel: 0870 333 0220**

Vokèra Ireland

West Court, Callan, Co Kilkenny

**Tel: 05677 55057 Fax: 05677 55060**

Vokèra Ltd. reserve the right to change the specifications without prior notice. Consumers' statutory rights are not affected.

A Riello Group Company



"Vokèra"  
supports Benchmark