

**Users Instructions and
Customer Care Guide**
R 25 & 30 HE combi Condensing boiler
R 28 HE system Condensing boiler

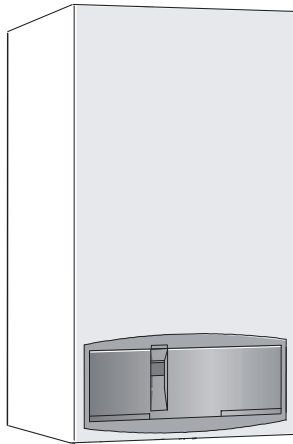

6 720 610 577-01.10

ZWB 7-25 R 25 HE GC-Number: 47 311 77
ZWB 7-30 R 30 HE GC-Number: 47 311 78
ZB 7-28 R 28 HE system GC-Number: 47 311 62

benchmark

6 720 610 577 GB (03.11) TD

 **WORCESTER**
Bosch Group

Contents

Contents

Excellence comes as standard	3
Safety precautions	4
1 General notes	5
2 Controls	9
3 Operating the Appliance	10
3.1 Preparation	10
3.2 Switching the Appliance On/Off	12
3.3 Switching on the Central Heating	13
3.4 Controlling Central Heating	13
3.5 R 25 & 30 Boilers: Setting the Hot Water Temperature	13
3.6 Summer Mode, Hot Water Only (R 25 & 30 Appliances)	15
3.7 Frost protection (R 25 & 30 Appliances)	16
3.8 Fault Condition	16
4 Tips on saving energy	17
5 General Information	19
6 Maintaining your appliance	19
7 Service	20
8 Fault or breakdown	21
9 Your guarantee	22
10 Guarantee registration	23
11 Operating Instructions Quick Reference	24

Excellence comes as standard

Thank you for purchasing an R 25 & 30/R 28 condensing appliance.

The R 25 & 30/R 28 Series has been developed by the Bosch Group and the strictest quality control standards are demanded throughout every stage of production.

Indeed, the Bosch Group have led the field in innovative appliance design and performance for many years.

The result is that your new R 25 & 30/R 28 appliance offers you the very best of everything – quality, efficiency, economical running costs, proven reliability and value for money.

What's more, you also have the assurance of our no nonsense 2 year parts and labour guarantee.

And it's backed up by Worcester Heat Systems Ltd. - Offering a complete maintenance scheme to keep your boiler operating at peak condition and efficiency.

No wonder that more and more people are agreeing that when it is gas, it has to be a Worcester Heat Systems Ltd. Condensing appliance.

Benchmark

The "Benchmark" initiative is the new code of practice to encourage the correct installation, commissioning and servicing of domestic central heating boilers and system equipment.

The "log-book" is a vital document that must be completed by the installer at the time of installation. It confirms that the boiler has been installed and commissioned according to the manufacturers' instructions.

Without the completion of the "log-book", manufacturers may refuse to respond to a call-out from a householder, who will be advised that he or she must call back the installer, who has not fulfilled his obligations to record the information required by the initiative.

Safety precautions

Safety precautions

Gas Safety (Installation and Use) Regulations 1998

It is the law that all gas appliances are installed by a competent person in accordance with the above regulations. Failure to install appliances correctly could lead to prosecution. It is in your interest, and that of safety, to ensure compliance with the law.

If you smell gas:

- ▶ Turn off gas service cock at the meter.
- ▶ Open all doors and windows.
- ▶ Do not operate any electrical switches.
- ▶ Do not smoke.
- ▶ Extinguish any naked flames.
- ▶ Call your gas company.

If you smell fumes from the appliance:

- ▶ Switch off appliance.
- ▶ Open windows and doors.
- ▶ Inform your heating engineer.

Fitting and modifications

- ▶ Fitting of the appliance or any modifications to the appliance may only be carried out by a competent person.
- ▶ Flue systems must not be modified in any way.

Maintenance

- ▶ We **recommend that you** take out a maintenance contract with a competent installer and have the appliance serviced at regular intervals.
- ▶ Ensure that your Service Engineer uses only genuine spare parts!

General notes

Combustible materials

- ▶ Do not store or use any combustible materials (paper, thinners, paints etc.) in the vicinity of the appliance.

Health and safety

- ▶ This appliance contains no asbestos products.
- ▶ There is no potential hazard due to the appliance being electrically unsafe.
- ▶ There are no substances used in the construction that are a potential hazard in relation to the COSHH Regulations (Control of Substances Hazardous to Health Regulations 1988).

Combustion Air/Ambient Air

- ▶ Keep combustion air/ambient air free of corrosive substances (e.g. halogenated hydrocarbons which contain chlorine or fluorine compounds). In this way corrosion can be prevented.

1 General notes

To get the best from your appliance please read these instructions carefully.

Sealed heating systems

The appliance is fitted to a sealed heating system which is pre-pressurised. Your installer will tell you of the minimum and maximum pressure which must be indicated on the pressure gauge.

Check regularly that the pressure is maintained and contact your installer or maintenance engineer if there is a permanent significant drop in the pressure. If the system loses pressure it should be repressurised and the cause of the fall investigated.

Central heating systems

During the first few hours of operation of the central heating system, check that all radiators are being heated at an even rate. If the top of a radiator is at a lower temperature than the bottom then it should be vented by releasing air through the venting screw at the top of the radiator. Ask your installer to show you how this is done.

General notes

Repeated venting will reduce the quantity of water in the system and this must be replenished for safe and satisfactory operation of the appliance.

Should water leaks be found in the system or excessive venting is required then a service engineer must be contacted to inspect the installation and rectify any fault.

Only additives that are compatible with aluminium may be used in the system. Any incompatible additive used will invalidate the guarantee.

Condensate drain

This is a condensing appliance and the terminal will, at times, give out a plume of water vapour. This is quite normal.

The appliance produces quantities of condensate which is discharged regularly through the siphon.

Clearances

Your installer will have provided adequate space around the appliance for safety and servicing access. Do not restrict this space with the addition of cupboards, shelves etc. next to the appliance.

Left-hand side	5 mm
Right-hand side	5 mm
In Front	600 mm
Above Casing (Vert. Flue)	200 mm
Above Flue Turret	30 mm
Below	200 mm

Table 1

Room thermostat

A room thermostat may be fitted to control the central heating. Refer to the instructions supplied with the thermostat for information on siting and setting. A programmable thermostat may also be used with this appliance to provide additional timed control of the central heating.

Thermostatic radiator valves

It is recommended that this type of valve is fitted to all the radiators except one, usually a radiator where the room thermostat is fitted. They should conform to the requirements of BS2767:10.

Showers, bidets, taps and mixing valves – R 25 & 30 Boilers

Standard hot and cold taps and mixing valves must be suitable for operating at mains pressure. Thermostatically controlled or pressure equalising shower valves will guard against the flow of water at too high a temperature.

Hot and cold mains fed water can be supplied directly to an over-rim flushing bidet subject to local water company requirements.

With all mains fed systems the flow of water from individual taps will vary with the number of outlets operated simultaneously and the cold water mains supply pressure to the property.

Flow balancing using “ball-o-fix” type valves is recommended to avoid an excessive reduction in flow to individual outlets.

For further information contact Worcester Heat Systems Ltd. Technical Services Department.

Hot and cold flow – R 25 & 30 Boilers

The flow of water demanded from both hot and cold service outlets is dependent upon the mains supply. It may not be possible in some installations to operate all outlets simultaneously.

Water mains failure – R 25 & 30 Boilers

If there is a failure of the mains water supply then no water will be available at a tap or shower until the mains supply is restored. The appliance will still operate in the central heating mode.

Use in hard water areas – R 25 & 30 Boilers

In exceptionally hard water areas a device to prevent scale formation may be fitted. Installation of a scale inhibitor assembly should be in accordance with the requirements of the local water company. An isolating valve should be fitted to allow for servicing.

General notes

Alternatively the maximum temperature of the domestic hot water may be reset to about 45 °C which will reduce the risk of scale formation in these hard water areas.

Ventilation

This is a room sealed appliance and does not require any air for combustion from inside the house. If the appliance is fitted into a cupboard or a compartment is built around the appliance after installation then the compartment must be separated from the boiler space by a perforated non-combustible partition as described in BS6798.

Notwithstanding the requirements of BS6798, there is no need for ventilation openings to be provided in the compartment because of the low heat loss from the casing.

Do not allow the flue terminal fitted on the outside wall to become obstructed or damaged.

Pump

The pump will have been set by the manufacturer and must not be manually re-adjusted.

2 Controls

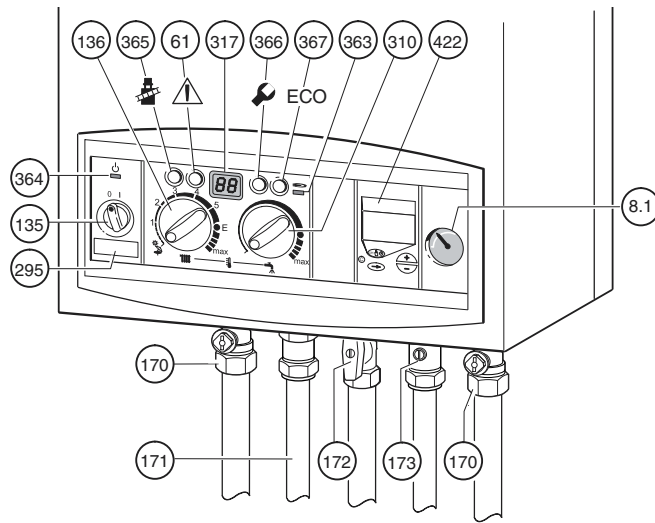

6 720 610 600-01.10

- 8.1** System Pressure gauge
- 61** Reset button
- 135** Master switch
- 136** Central heating temperature control
- 170** Service valves in CH flow and return
- 171** Hot water
- 172** Gas isolation valve (open)
- 173** Cold water inlet
- 295** Identification sticker
- 310** Hot water temperature control (R 25 & 30)
- 317** Display
- 363** Indicator lamp for "burner on"
- 364** Indicator lamp for "off/on"
- 365** "Chimney sweep" button
- 366** Service button
- 367** "ECO" button
- 422** Optional timer

Operating the Appliance

3 Operating the Appliance

3.1 Preparation

Turn on the gas cock (172).

- ▶ Press in the handle and turn it anti-clockwise as far as the stop (when handle is in line with direction of flow, the cock is open).

Central heating system valves (170)

- ▶ Using a spanner, turn square nut until groove is in line with direction of flow (see detail).
Groove at right angles to direction of flow = off.

Cold water inlet valve (173)

- ▶ Turn handle so that it is in line with direction of flow.
When handle is at right angles to direction of flow, the valve is closed.

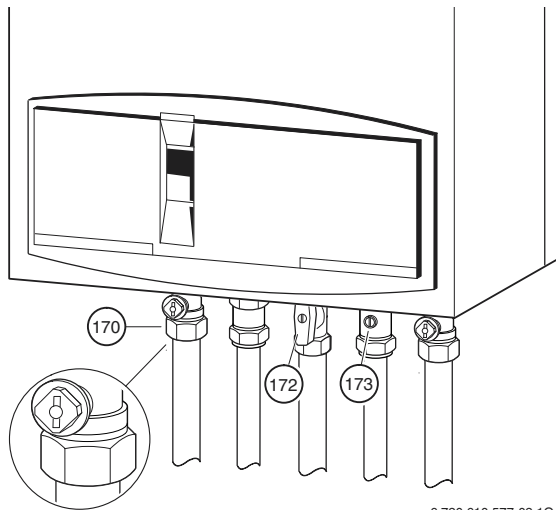

Operating the Appliance

Check the central heating system pressure

- ▶ The pointer on the pressure gauge (8.1) should be about 1 bar.
- ▶ If the pointer is below 1 bar (when the system is cold), top up the system with water until the pointer is 1 bar. Your installer will have shown you how to do this.
- ▶ The **maximum operating pressure** of 2.5 bar at maximum central heating flow temperature must not be exceeded. If the pressure increases to 3 bar then the relief valve (15) opens.

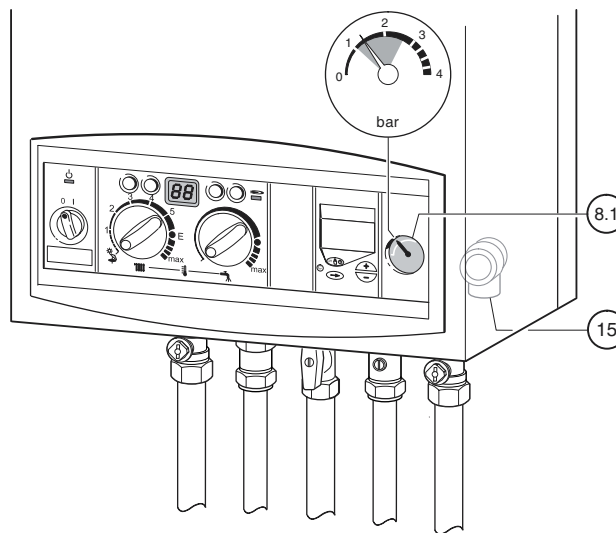

6 720 610 600-03.10

Operating the Appliance

3.2 Switching the Appliance On/Off

Switching on

- ▶ Switch on the appliance at the master switch **(I)**.
The indicator lamp shows green and the display will show the central heating flow temperature, when the appliance is operating in the central heating mode.

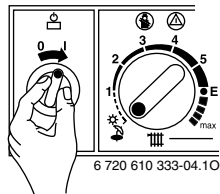

If the display alternates between

-II-

and the central heating flow temperature, the trap filling programme is active.

The trap filling programme ensures that the condensation trap is filled after the appliance has been installed or after the appliance has been out of use for a long period. For that reason, the appliance remains at minimum heating output for 15 minutes.

Switching off

- ▶ Switch off the appliance at the master switch **(0)**.
The green indicator lamp goes out. The optional timer will continue running until the emergency supply is exhausted.

3.3 Switching on the Central Heating

- ▶ Turn the central heating temperature control  to the desired level:
 - “Min” setting: 35°C
 - Low-temperature heating: setting “E” (approx. 75°C)
 - “Max” setting: 88°C

When the burner is lit, the **red** indicator lamp is illuminated.

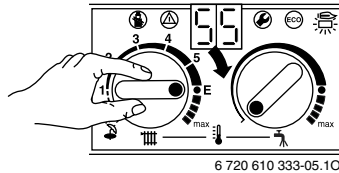

3.4 Controlling Central Heating

- ▶ Set room thermostat to the desired room temperature.
- ▶ Set room temperature controller unit, if fitted. Refer to the instructions with the control.
- ▶ Set the thermostatic radiator valves to the desired settings.

3.5 R 25 & 30 Boilers: Setting the Hot Water Temperature

Hot water temperature

On R 25 & 30 models, the hot water temperature can be set to between approx. 40°C and 60°C using the temperature control .

The domestic hot water temperature is not shown on the display.

Operating the Appliance

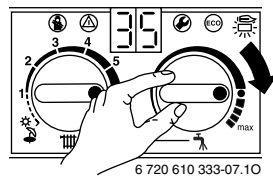

Control Setting	Water Temperature
Anti-clockwise limit	approx. 40°C
●	approx. 55°C
Clockwise limit	approx. 60°C

Table 2

“ECO” button

By pressing and holding the “ECO” button (ECO), until the display lights, you can switch between **Comfort mode** and **Economy mode**.

Comfort mode: button is not lit (factory setting)

The appliance is held constantly at the set temperature. This means that hot water is available almost instantaneously at the tap. Consequently the appliance will switch on at intervals, even if no hot water is being drawn.

ECO mode with demand detection, button is lit

The demand detection function enables maximum gas and water economy.

Briefly turning a hot water tap on and then off again signals demand to the appliance which then heats up the water to the set temperature.

Hot water is thus available in about 1 minute.

ECO mode, button is lit

Water is not heated up until hot water is drawn. This means that there is a longer waiting period before hot water is available.

3.6 Summer Mode, Hot Water Only (R 25 & 30 Appliances)

With room thermostat

- ▶ Turn temperature control  on the appliance anti-clockwise as far as the stop.
The central heating is now turned off. The hot water function and the mains power supply for the heating programmer and timer remain switched on.

Operating the Appliance

3.7 Frost protection (R 25 & 30 Appliances)

- ▶ Leave master switch switched on.

If the appliance is to be left for long periods switch the central heating off:

- ▶ Add a suitable anti-freeze fluid to the water in the central heating system.
Suitable products are available from Betz-Dearborn Tel.: 0151 4209563, Fernox Tel.: 01799 550811 and Salamander on 0121 378 0952.

3.8 Fault Condition

In the unlikely event of a fault occurring while the appliance is in operation:

The display then shows a fault code and the button  may also flash.

If the button  flashes:

- ▶ Press and hold the button  until the display shows “- -”.
The appliance will then start up again and the display will show the central heating flow temperature.

If the button  does not flash:

- ▶ Switch the appliance off and then on again at the master switch.
The appliance will start up again and the central heating flow temperature will be displayed.

If the fault remains and can not be cleared:

- ▶ Call Worcester Heat Systems Ltd. for assistance, giving a description of the fault and, if possible, the fault code from the facia display.

4 Tips on saving energy

Heating economically

The boiler is designed to provide a high level of comfort while keeping gas consumption and the resulting environmental effect as low as possible. The gas supply to the burner is controlled according to the level of demand for heat. The boiler continues to operate with a low flame if the demand for heat reduces. The technical term for this process is modulating control. Modulating control keeps temperature fluctuations small and provides even distribution of heat throughout the home. This means that the boiler may stay on for relatively long periods but will use less gas than an appliance that continually switches on and off.

Central heating systems with room thermostats/thermostatic radiator valves

The central heating control on the boiler should be set to the maximum rated temperature of the central heating system or to position "E", when the maximum central heating water temperature obtained is 75°C.

The temperature can be set individually in each room (except primary room with the room thermostat) using the thermostatic radiator valves. If you wish to have a lower temperature in the primary room than in the other rooms, leave the room thermostat at the set temperature and turn down the radiator using the radiator valve.

Reduced-output operation

Considerable fuel savings can be made by slightly reducing the room temperature. Lowering the temperature by 1°C can bring about energy savings of up to 5%. However, it is not advisable to allow the room temperature to fall below +15°C. The room temperature for reduced-output mode can be set separately on the room thermostat. Instructions are given in the control unit operating instructions.

Tips on saving energy

Hot water

A lower setting on the hot water temperature control can result in considerable energy savings.

For R 25 & 30 appliances:

The **on-demand activation** using the ECO-button makes possible the maximum savings of gas and water.

Now you know how to heat your home economically with the R 25 & 30/R 28 gas condensing boiler. If you have any other questions, please contact your installer – or write to us.

5 General Information

Cleaning the Outer Case

Wipe down the outer case with a damp cloth. Do not use abrasive or caustic cleaning agents.

Appliance details

If you ever need to call Customer Service it helps us a great deal if you can provide precise details of your appliance.

The information is printed on the appliance identification plate/ sticker (see page 9, item 295).

Your installer will have completed the Benchmark "log-book" giving details of the boiler together with name, address and registration number. Have the "log-book" to hand when calling a Service Engineer.

6 Maintaining your appliance

Your new R 25 & 30/R 28 gas-fired appliance represents a long-term investment in a reliable, high quality product.

In order to realise its maximum working life, and to ensure it continues to operate at peak efficiency and performance, it is essential that your boiler receives regular, competent servicing and maintenance checks beyond the initial 2 year guarantee period.

If you would like to know more about a Worcester Bosch service contract, please tick the appropriate box on your warranty registration card.

Service

7 Service

If your R 25 & 30/R 28 appliance should fail to operate correctly or requires servicing please call Worcester Heat Systems Ltd. on: 08457 256 206.

8 Fault or breakdown

This product is supported in the UK by Worcester Heat Systems Ltd. – part of the Bosch Group.

A specialist factory trained field SERVICE ENGINEER is available to attend a breakdown or manufacturing fault occurring on this appliance.

No charge will be made for parts and/or labour providing:

- An appliance fault is found and the appliance has been installed within the past 24 months. Reasonable evidence of this must be supplied on request.

A call-out charge will be made where:

- The appliance has been installed for over 24 months.
OR
- Our Field Service Engineer finds no fault with the appliance (see **NOTE**).
OR
- The cause of breakdown is misuse or with other parts of your plumbing/heating system, or with equipment not supplied by Worcester.

NOTE: No appliance fault is found on over 30 % of all service call outs.

If in doubt contact our Worcester Heat Systems Ltd. on 08705 266241.

IN THE EVENT OF AN APPLIANCE FAULT OR BREAK-DOWN please contact your Service Centre. Your service administrator will arrange for an engineer to call with the minimum of delay; under normal circumstances this will be within the period 1-3 working days (excluding weekends) for priority breakdown situations (no hot water and/or heating service).

INVOICES FOR ATTENDANCE AND REPAIR WORK CARRIED OUT ON THIS APPLIANCE BY ANY THIRD PARTY WILL NOT BE ACCEPTED.

Your guarantee

9 Your guarantee

This appliance is guaranteed against faulty material or workmanship for a period of 24 calendar months from the date of installation subject to the following conditions and exceptions.

- That during the currency of this guarantee any components of the unit which are proved to be faulty or defective in manufacture will be exchanged or repaired free of material charges and free of labour charges by Worcester Heat Systems Limited.
- That the householder may be asked to prove the date of installation, that the appliance was correctly commissioned and, where appropriate, the first 2 year service has been carried out to the satisfaction of Worcester Heat Systems Limited when requested.
- That any product or part thereof returned for servicing under the guarantee must be accompanied by a claim stating the Model, Serial Number, Date of Installation.
- That Worcester Heat Systems Limited will not accept responsibility for damage caused by faulty installation, neglect, misuse or accidental damage, the non observance of the instructions contained in the Installation and Users Instructions Leaflets.
- That the appliance has been used only for normal domestic purposes for which it was designed.
- That this guarantee applies only to equipment purchased and used in Great Britain.

This guarantee is given in addition to all your normal statutory rights.

10 Guarantee registration

You should complete and return the postpaid Guarantee Registration Card within 14 days of purchase.

The card will register you as the owner of your new appliance and will assist us in maintaining an effective and efficient customer service by establishing a reference and permanent record for your boiler.

This will not affect your statutory rights in any way.

Important:

For your own record:

Model

.....

Serial number:.....

(See identity label inside appliance casing)

Type/size:.....

Date of installation:.....

Check that the Benchmark "log-book" has been completed by your installer or service engineer.

EXCELLENCE COMES AS STANDARD

**Worcester Heat Systems, Cotswold Way, Warndon,
Worcester WR4 9SW.**

Telephone: (01905) 754624 Fax: (01905) 754619

SERIAL NUMBER. Copy the number off the Guarantee Card.

Notice

11 Operating Instructions Quick Reference

Switching on

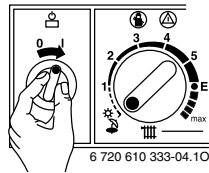

Switching the central heating on

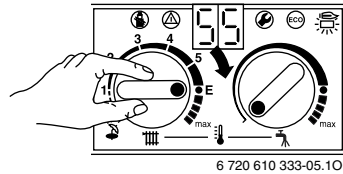

Controlling the central heating

Set room thermostat to desired temperature or the remote temperature control unit to the appropriate setting.

Hot water temperature

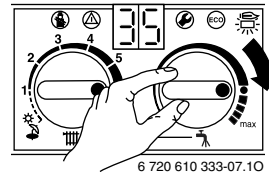

“ECO”-button lit –

Economy mode.

“ECO”-button not lit –

Comfort mode

Hot water only

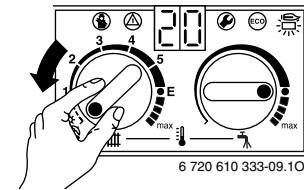

Fault Condition

If the  button flashes, press and hold-in to reset the appliance. Refer to page 16.

Switching off

